

## Universal Stringing Roller Adapters & Dumping Stringing Roller Adapters

### 5900 Universal Crossarm Adapter (For mounting 5900 Series Rollers.)

The No. 5900 Crossarm Adapter is designed to fit 4" x 5" and 5" x 6" Crossarms. It provides a cam action that forces the mounting bolts against the crossarm when the wing nuts are tightened. This feature compensates for allowable dimensional variations to provide a more rigid mounting.

The No. 5900 provides a base for crossarm mounting the No. 5902 and 5903 Rollers vertically at 221/2' and 45'. The No. 5900 is lightweight, high strength 356-T6 aluminum alloy.

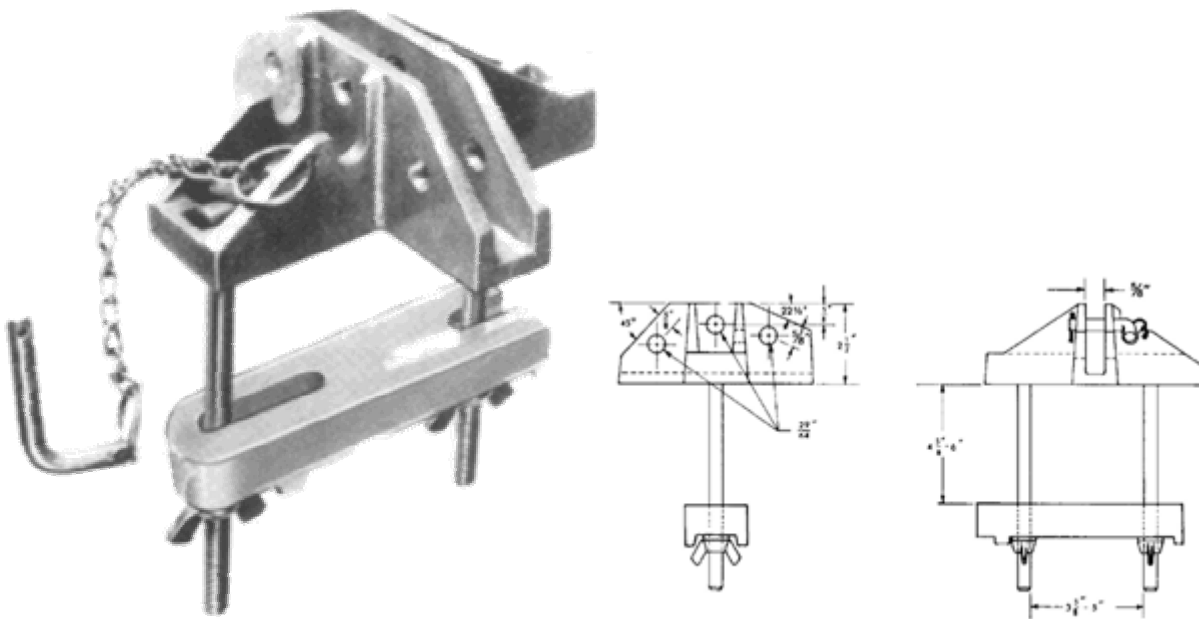

U.S. PATENT 3,822,862 and 3,918,685

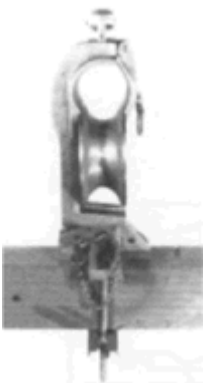

Combination of - 5902-S and 5900

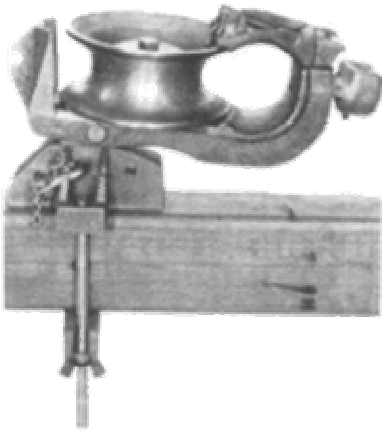

Combination of - 5902-S, 5906 and 5900

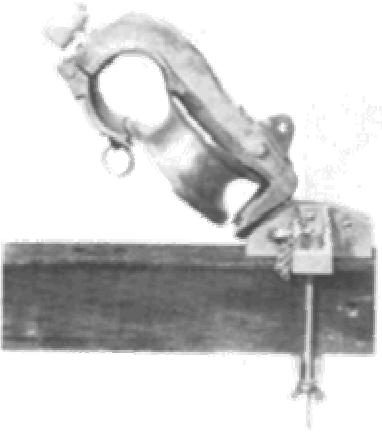

Combination of - 5902-S and 5900

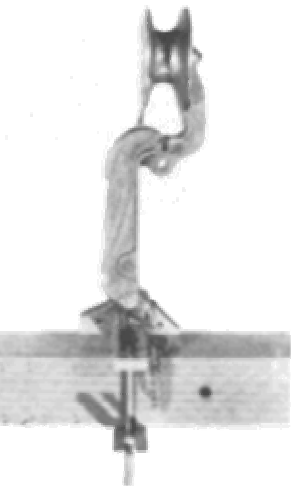

Combination of - 5903 and 5900

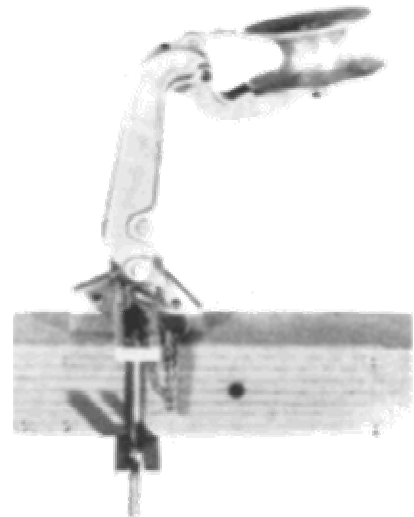

Combination of - 5903 and 5900

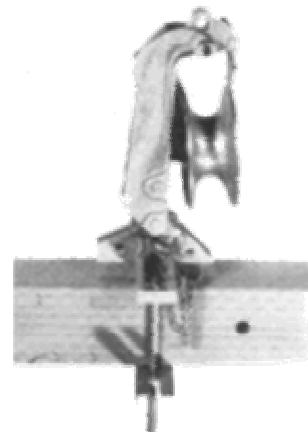

Combination of - 5903 and 5900